

Art. M489B+ M587A

Miscelatore doccia incasso

- maniglie
- deviatore a rotazione a 3 uscite
- ingressi da 1/2"
- isolamento acustico

Parte esterna

Finiture:

- Cromo** 24 02 M489B
- Nero Opaco** 24 13 M489B

Parte da incasso

Finiture:

- 44 00 M587A

Progetto:

Stanza:

Data:

Commento:

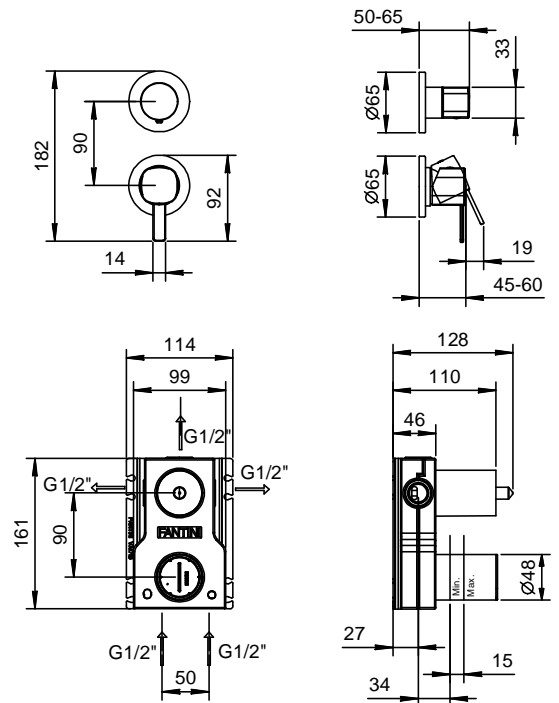

Certificazioni: